

# STUDIO•M

SM36344

Please consult your electrician for hanging fixture and wiring.

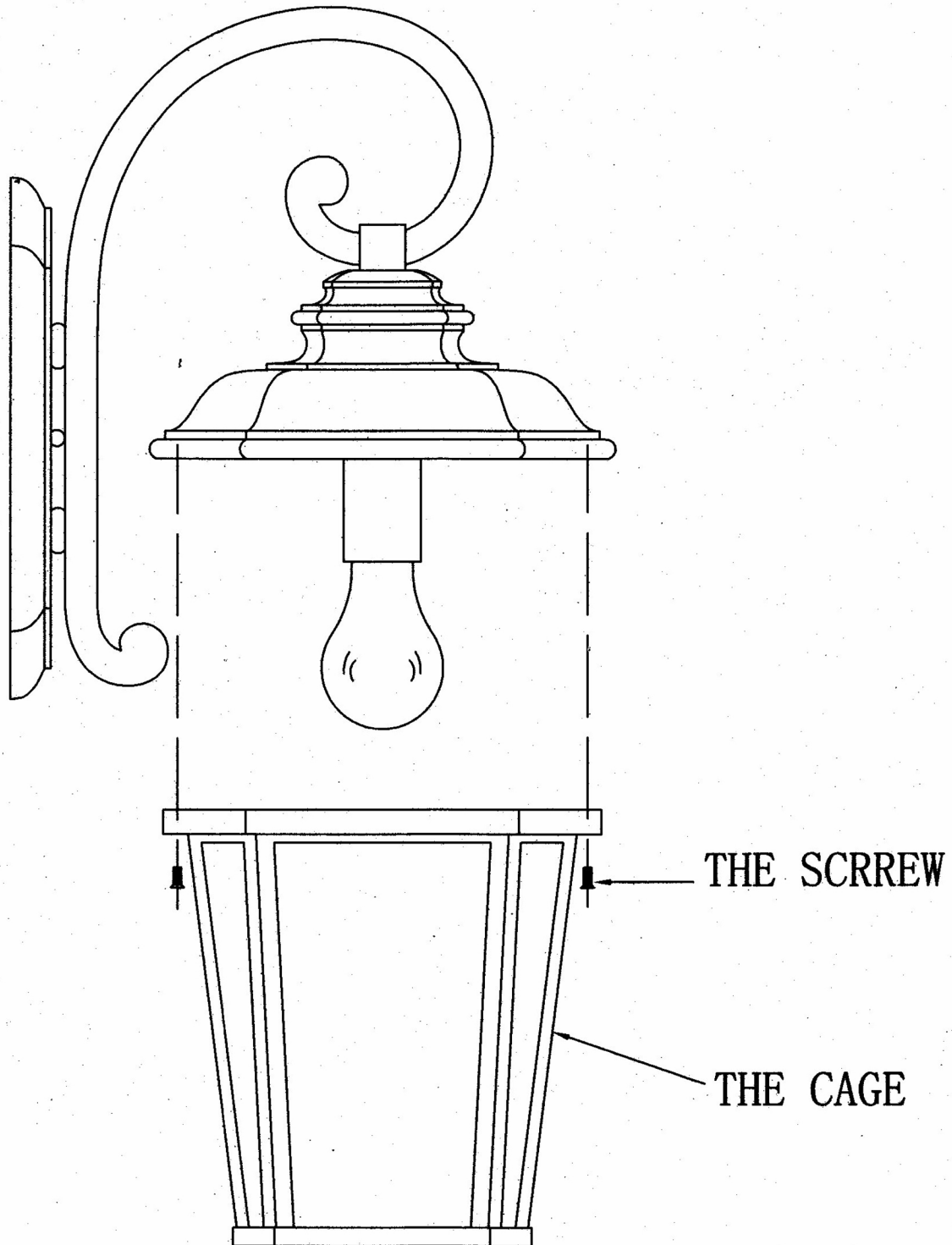

# STUDIO•M

SM36344

Please consult your electrician for hanging fixture and wiring.

Please read the instructions carefully before installation of your Lighting Fixture. Referring to the drawing below, you have to determine the type of fixture which you have purchased "Single Strap Mounted" or "Swivel Strap Mounted" and proceed accordingly

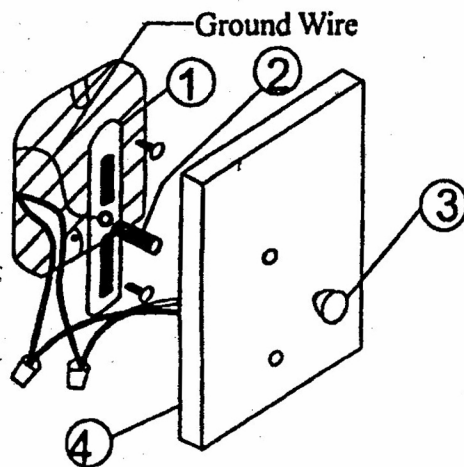

1. Single cross bar
2. Threaded nipple
3. Threaded cap
4. Fixture canopy

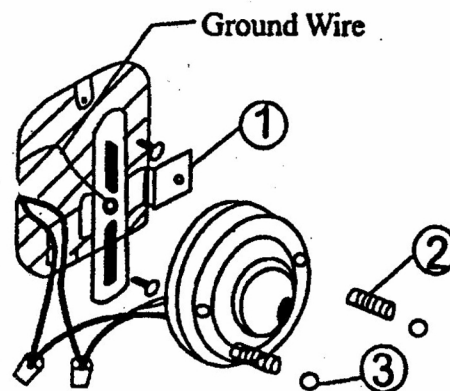

1. Swivel cross bar
2. Threaded screw pin
3. Ball knobs
4. Fixture canopy

## Installation Procedures

1. Switch off the power supply to the outlet box on which you plan to mount the lighting fixture  
(Caution: Disconnect all power before servicing)
2. Fix the cross bar to outlet box by using existing outlet box screws
3. Connect fixture wires to house wires. Ensure the right matching as black to black, white to white. Secure house ground wire to the cross bar ground wire screw (Caution: Make sure connections are secure, in Right Polarity and in Good Insulation)
4. Mount Lighting Fixture according to the drawing above
5. Caulk with silicon or similar caulking suitable for outdoor use  
Make a complete seal around fixture canopy and mounting surface

**Warning – Do not adjust metal shade to the point where it makes contact with the wall .  
Contact of metal shade with the wall may transfer heat and become a potential fire hazard.**